

INSTRUCTION MANUAL

ventairtm

THE AIR MOVEMENT SPECIALISTS

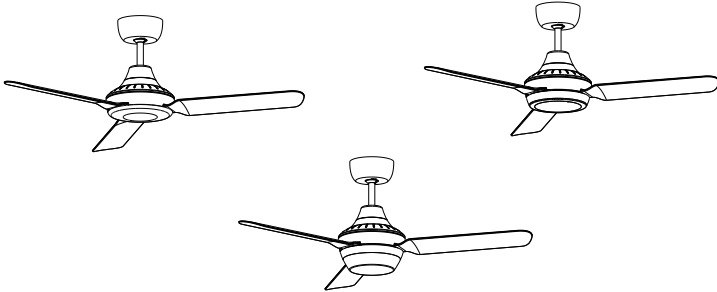

(This photo is for reference only; it does not mean you are purchasing an identical product. Fan picture is for illustration purposes only. Styles may vary according to the model.)

Ceiling Fan Installation Manual, Rev 1.0

STANZA

CEILING FAN INNOVATION

Model: STA903WH STA903WH-L
 STA903BL STA903BL-L
 STA903BLLED STA903WHLED
 STA903CL
 STA1203WH STA1203WH-L
 STA1203WHLED STA1203BL
 STA1203BL-L STA1203BLLED
 STA1203CL
 STA1403WH STA1403WH-L
 STA1403WHLED STA1403BL
 STA1403BL-L STA1403BLLED
 STA1403CL

CAUTION

Read Instructions Carefully
For Safe Installation and
Fan Operation

- INSTALLATION
- OPERATION
- MAINTENANCE
- WARRANTY INFORMATION



**MUST BE
INSTALLED
BY A LICENSED
ELECTRICIAN**

THANK YOU FOR PURCHASING

Thank you for purchasing this quality Ventair ceiling fan. To ensure correct function and safety, please read all instructions before using the product and keep all instructions for future reference.

SAFETY PRECAUTIONS

The information contained in the following pages has been prepared to ensure you of trouble-free operation of your ceiling fan.

1. To ensure the success of the installation, be sure to read the instructions and study the diagrams thoroughly.
2. All electrical work should only commence after disconnection of the power. Remove fuses or turn off the circuit breaker to ensure all pole isolation of the electrical supply.
3. Make sure that your installation site will not allow the rotating fan blades to come in contact with any object and that there is a minimum clearance of 150mm from the blade tip to the wall or ceiling. Please note that the greater the clearance around the fan, the better the airflow will be.
4. The fixing point for the fan must be able to support the weight of 4 times that of the net weight of the fan. Net weights can be found on the next page. If you are mounting the fan to a ceiling junction box, the box and fixing must be able to support the moving weight of the fan and must not twist or work loose.
5. The fan must be earthed.
6. Do not connect the fan motor to a dimmer switch. This may give an unsatisfactory performance (motor hum) and cause damage to the motor.
7. It is not recommended that ceiling fans and gas appliances be operated in the same room at the same time.
8. Do not insert anything into the fan blades while the fan is operating. This will damage the blades and upset the balance of the unit causing the unit to wobble.
9. After the fan is completely installed, make sure that all connections are secured and tightened to prevent any problems.
10. Because of the fan's natural movement, some connections may loosen. Check the support connections, brackets and blade attachments twice a year to make sure they are all secured. If they are loose, tighten with a screwdriver.
11. Always have your fan installed by a licensed electrician.
12. This appliance is not intended for use by persons (including children) with reduced physical, sensory or mental capabilities, or lack of experience and knowledge, unless they have been given supervision or instruction concerning use of the appliance by a person responsible for their safety.
13. Children should be supervised to ensure that they do not play with the appliance.
14. The fan is to be installed so that the blades are at least 2.1 meters or more above the floor.

IMPORTANT:

This fan is suitable for indoor/ fully covered outdoor use only.

An all-pole disconnection switch must be incorporated into the fixed wiring, in accordance with local wiring rules.

SPECIFICATION

MODEL	Light Wattage (W)	Fan Wattage (W)	Voltage (V)	Frequency (Hz)	Net Weight (Kg)
STA903WH STA903BL STA903CL	No Light	45 watts	220-240 V	50Hz	4. 2kg
STA903WH-L STA903BL-L	2xB22 bulbs Max 15W	45 watts	220-240 V	50Hz	4. 4kg
STA903WHLED STA903BLED	20 watts	45 watts	220-240 V	50Hz	4. 4kg
STA1203WH STA1203BL STA1203CL	No Light	55 watts	220-240 V	50Hz	6.80kg
STA1203WH-L STA1203BL-L	2xB22 bulbs Max 15W	55 watts	220-240 V	50Hz	7.0kg
STA1203WHLED STA1203BLED	20 watts	55 watts	220-240 V	50Hz	7.0kg
STA1403WH STA1403BL STA1403CL	No Light	68 watts	220-240 V	50Hz	7.60kg
STA1403WHLED STA1403BLED	20 watts	68 watts	220-240 V	50Hz	7.80kg
STA1403WH-L STA1403BL-L	2xB22 bulbs Max 15W	68 watts	220-240 V	50Hz	7.80kg

PARTS LIST

Unpack the fan and carefully identify the parts. Please refer to Fig1.

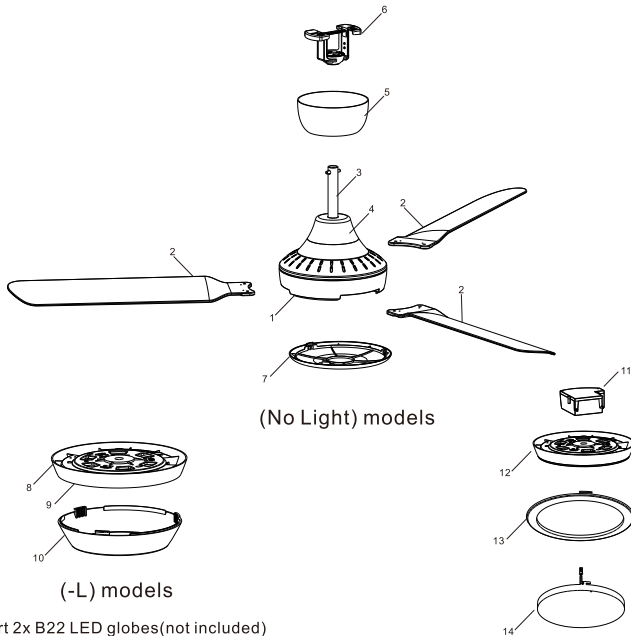

Part	Pcs
1.Motor Assembly	1
2.Blades	3
3.Down Rod	1
4.Lower Canopy	1
5.Upper Canopy	1
6.Hang-Sure Set	1
7.Fascia	1
8.Light frame	1
9.B22 lamp holders	1
10.Light diffuser	1
11.LED Light Driver	1
12.Light frame	1
13.Decorative Ring	1
14.LED Light Panel	1

Insert 2x B22 LED globes(not included)
Suggest T40 LED globes (max. 120mm length)

(LED) models

INSTALLATION

Mounting Plate Hanging System

1. Ceiling Joist
2. Canopy
3. Quick Fix terminal Block
4. Earth Wire
5. Hanger Ball
6. Down Rod
7. Safety steel wire(to be fixed on the bracket via the screw)

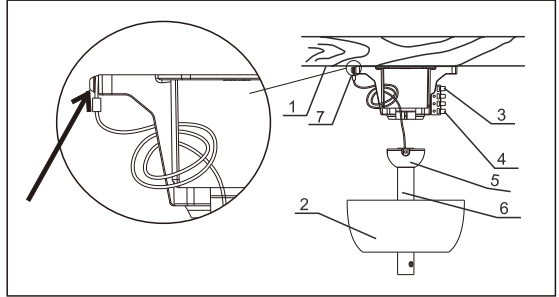

Fix Bracket to ceiling.

- 1.Ensure Bracing structure is solid and firm and able to support at least 4 times the weight of the actual fan.
- 2.Bracket must be fixed securely using only the specially rated screws provided. (failure to comply may result in voiding of warranty)
- 3.Ensure fixing and Bracing structure allows no movement, as this can cause unnecessary noises and wear and tear on the parts.



Please ensure the fixing tab fits into the groove of the hanger ball.

INSTALLATION ON A RAKED CEILING

- 1.Please ensure the fixing tab fits in the groove of the hanger ball.
- 2.Ensure the fixing tab is set at the highest point.

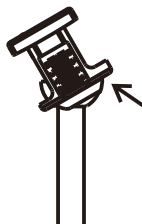
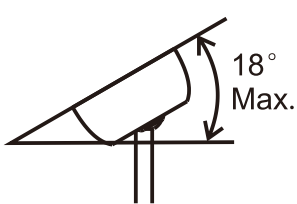

Fixing tab at highest point

BLADE ASSEMBLY

1. Remove light diffuser (Turning counterclockwise direction)
2. Attaching blades in hanging position

NOTE: 'THIS SIDE UP' text on the blades should be facing upwards once the fan is installed.

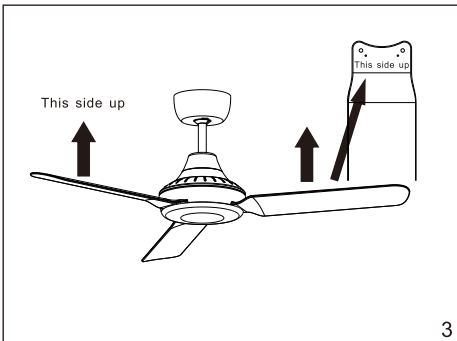
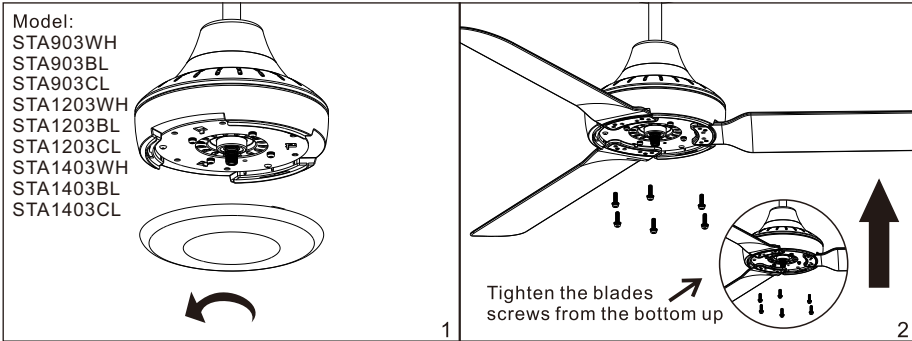

Model:
STA903WHLED
STA903BLED
STA1203WHLED
STA1203BLED
STA1403WHLED
STA1403BLED

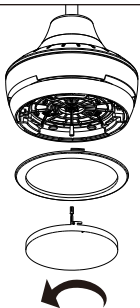

1

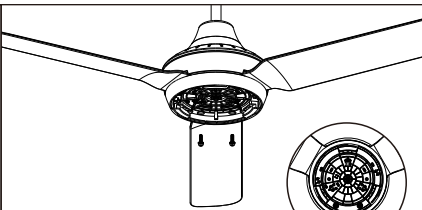

Align blade holes with opening in light frame and secure blades with screws provided

2

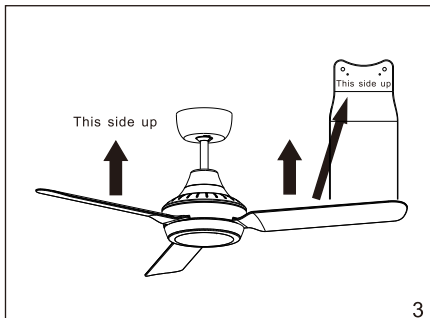

3

Model:
STA903WH-L
STA903BL-L
STA1203WH-L
STA1203BL-L
STA1403WH-L
STA1403BL-L

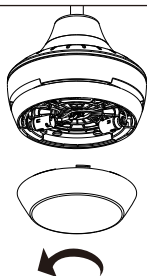

1

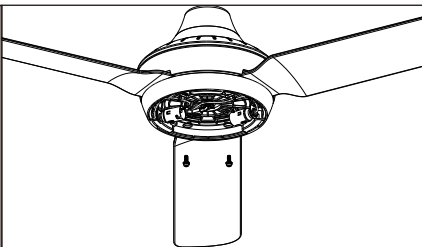

Align blade holes with opening in light frame and secure blades with screws provided

2

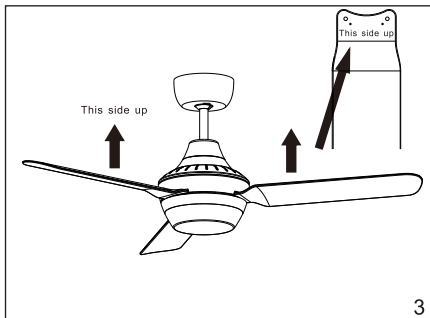

3

LIGHT KIT ASSEMBLY

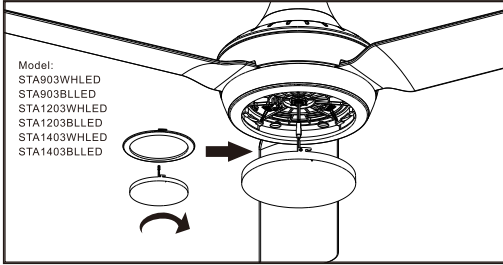

For (LED) models: After installing the fan blades, insert the light wire on the light frame into the terminal next to it, and then screw on the decorative ring and LED light panel.

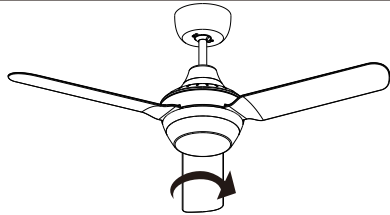
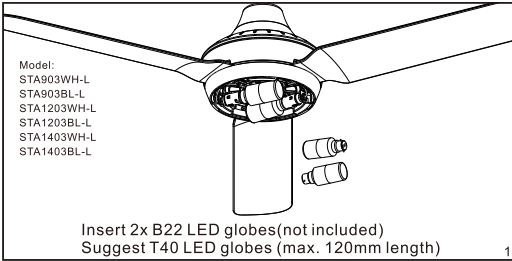

Replace diffuser (Turning clockwise direction)

WARNING:

For your safety, ensure the mains supply is switched off at the wiring circuit before performing any electrical tasks.

INSTALLING OPTIONAL REMOTE CONTROL

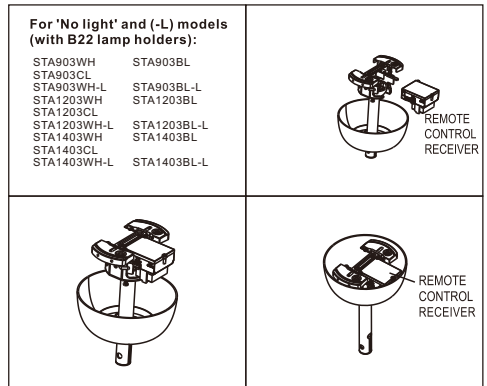
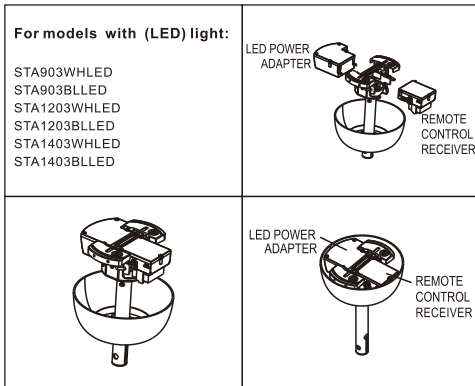

The remote handpiece comes factory paired with the remote receiver, but if you wish to pair a remote handpiece to multiple fans, see below)

Step 1: Turn "OFF" isolation switch.

Step 2: Turn "ON" isolation switch and within 10 seconds, press LIGHT "ON" button for 3-4 seconds until a "Tick-Tack" sound is heard. (Repeat steps above if not successful).

STEP DIMMING INSTRUCTIONS

Using a Standard Wall Control

1. Flick switch to 'ON' – Light will be at 100%.
2. While 'ON', flick switch to 'OFF' then 'ON' again within 2 seconds – Light will be at 75%.
3. Continue same process to reach 50% and 25% light level.

NOTE: If the light switch is 'OFF' for more than 2 seconds, it will revert to 100% light setting when next operated.

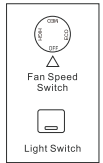

Using Remote Control (Not Included)

1. Use Eco/Med/High buttons to alter the fan speed.
2. "OFF" button will turn the fan off only.
3. Turn Light "ON/OFF" for light.
4. Press the "STEP DIM" button to transition through 75%, 50%, 25% then back to 100% of light output.

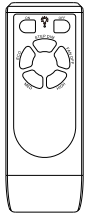

WIRING DIAGRAM OF WALL CONTROL TERMINAL

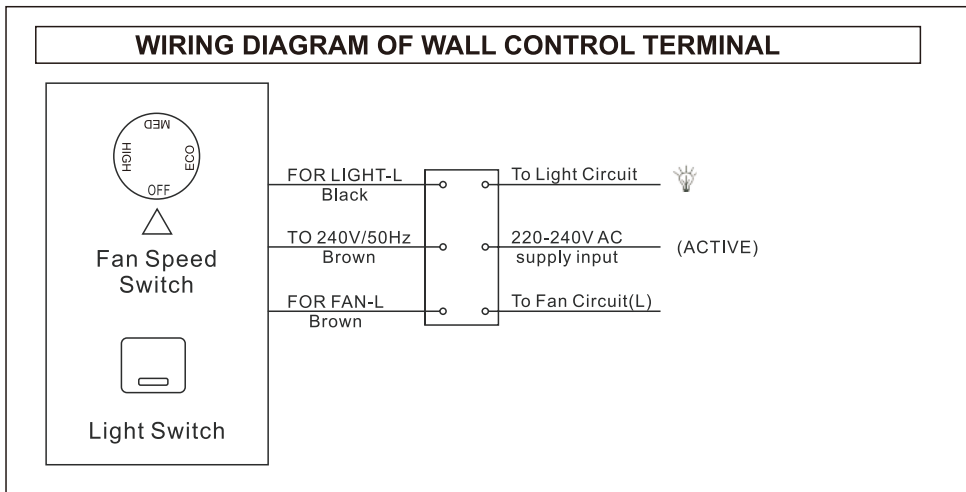

WARNING: FOR YOUR SAFETY, ENSURE THE MAINS SUPPLY IS SWITCHED OFF TO THE WIRING CIRCUIT BEFORE PERFORMING ANY ELECTRICAL TASKS.

HOW TO OPERATE

To turn the fan on, simply turn the switch knob to the (1, 2, 3) position.
To turn off, turn the switch knob to the OFF position.

WIRING DIAGRAM FOR MOUNTING BRACKET TERMINAL & WALL CONTROL

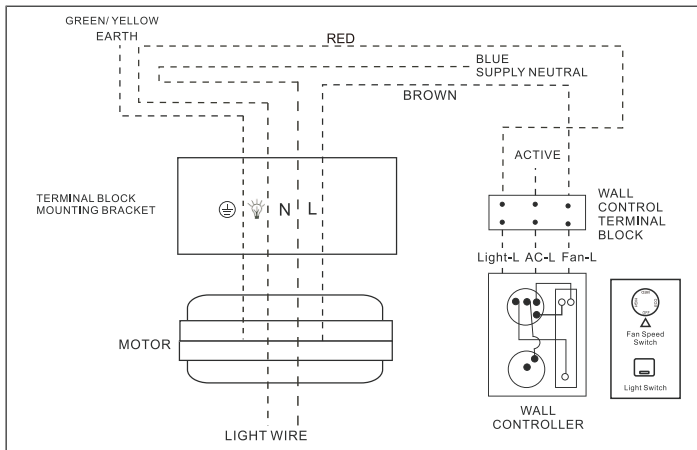

Step A: Connect the EARTH wire to the terminal port marked ‘⊕’ on the terminal block mounting bracket.

Step B: Connect the supply LIVE wire to the wall controller terminal port labelled “TO 240V/50HZ”.

Step C: Connect a wire from the Fan Live “L” from the terminal block mounting bracket, to the terminal port labelled “FOR FAN-L” on the wall controller.

Step D: Connect a wire from the Light Live “💡” from the terminal mounting bracket, to the terminal port labelled “FOR LIGHT-L” on the wall controller.

NOTE: The fan light wiring is only applicable to fan models with a light.

Step E: Connect the supply Neutral wire to the terminal port marked “N” on the terminal block mounting bracket.

WIRING DIAGRAM FOR ISOLATION SWITCH WITH REMOTE CONTROL

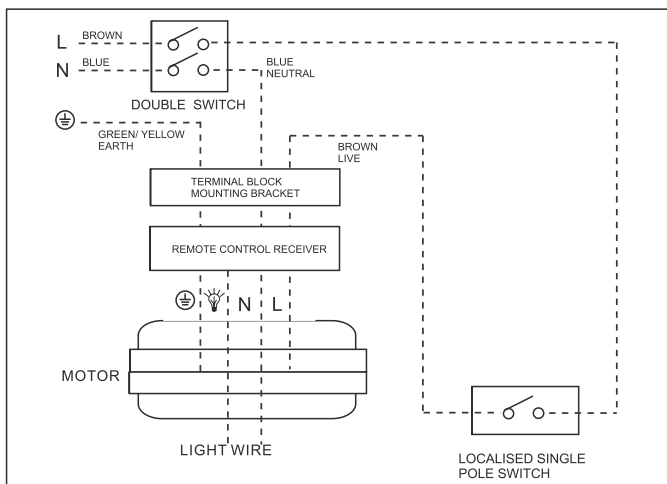

Step 1: Connect the EARTH wire to the terminal port marked “⊕” on the terminal block mounting bracket.

Step 2 : Connect the supply LIVE wire to Localised single pole switch and then wire to terminal port marked “L” on the terminal block mounting bracket.

Step 3: Connect the supply Neutral wire to the terminal port marked “N” on the terminal block mounting bracket

Once all the above steps have been followed, you are now ready to restore the mains power supply. Make sure there is nobody near or under the fan, then turn ON the fan (and light switch if included in your model) to test.

INSTALLATION TIPS

The fixing point for the fan must be able to support the weight of 4 times that of the net weight of the fan. If you are mounting the fan to a ceiling junction box, the box and fixing must be able to support the moving weight of the fan and must not twist or work loose.

All pole disconnection switches must be included in the fixed wiring.

- Only use the included wall control plate. Using other wall control plates will void warranty and may damage the fan.
- Do not use a solid state dimmer control.
- Do not use the light switch to control the fan motor.
- The wall control shall fit into existing gang block or wall plate. If you do not flush mount the control, use a standard single gang mounting block.
- Careful not to mix the supply live and the fan live connection. Reverse connection of the speed control will affect the correct operation of the fan.
- After the wiring connections are completed, ensure that all wires are arranged in a tidy manner, and make sure the ball sits well into the bracket, as it is important to reduce your fan from wobbling.

MAINTENANCE AND TROUBLESHOOTING

- Keep the fan clean. Wipe away dirt with a clean soft cloth, ordinary soap and water, wipe dry. Do not use solvents, etc. (Gasoline or petroleum.)
- Make sure to disconnect the power supply before cleaning and maintenance is carried out.
- Ensure that the fan is switched off from the supply mains before removing the guard.

The points described below should be checked, and corrected if necessary, upon installation and at least once a year thereafter.

Excessive movement and wobbling?

- Check all screws, bolts and nuts are secured tightly.
- Change position of the blades.
- Check blade height. Carefully rotate the fan and measure each blade from a fixed point on the ceiling. (Adjust if necessary, by loosening and re tightening the upper or lower blade screws)

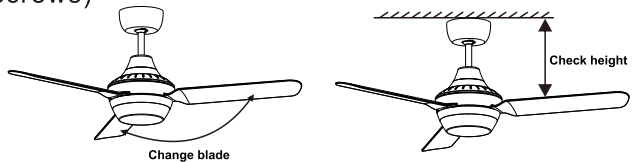

Does the motor, down rod or other components shake or vibrate abnormally?

Shaking and abnormal vibration can be caused if the blade holding screws or screws for the suspended parts are loose, or if a blade is deformed. If a blade is deformed, all 3 (or 4) blades should be replaced as a set.

Is there any unusual noise such as knocking or ticking?

Are the blade holding screws or screws for the suspended parts loose?

1. Make sure the bracing structure is sound and firm. Even slightly loose fixings may create knocking or ticking that will reverberate down through the fan. Upper canopy should not be in contact with the ceiling surface. It is suggested to leave an even 1mm to 4mm gap between ceiling and edge of upper canopy.
2. Irregular humming noise may be caused by electrical interference from another appliance, or ripple control signals being introduced by electricity provider.

Night Noise:

This is the biggest cause for service calls, which are outside the manufacturer's warranty. If a fan has a fault, it will always be noticeable. Naturally when everything is quiet at night, you will be more inclined to hear small noises, which may not be noticeable at other times. Even slight power fluctuations and/or mains frequency control signals superimposed in your electricity supply for off-peak hot water control may cause a change in fan motor noise. This is normal.

WARNING:

If at any stage the fan develops excessive wobbling or unusual oscillating movement is observed, immediately stop using the ceiling fan and contact the manufacturer, its service agent or suitably qualified persons.

Fan Light:

Except for an actual fault in manufacturing, which is extremely rare, noises and vibrations are often more accentuated when a fan light is fitted. For instance, a fan light glass that has not been tightened or worked loose can cause a rattle. Frequent care and maintenance will reduce this.



Do not dispose of electrical products with household waste. Please check with your local council for advice on disposal or recycling. If electrical appliances are disposed of in landfills or dumps, hazardous substances can leak into the groundwater and get into the food chain, damaging your health and well-being.

ventairtm
THE AIR MOVEMENT SPECIALISTS

4 CAPITAL PLACE
CARRUM DOWNS VIC 3201
PHONE: (03) 9775 0556
FAX: (03) 9775 0775